



Ligamed
Corporation



L-rangoscope
&
Diagnostic
CATLOGE



About Us

"Ligamed Corporation" is family owned business in Sialkot, who has been in the line of business since 1990. We have extensive experience, and have gained a good repute in the field of export. Now we, the second generation, are successfully running our business.

Products And Services

We manufacture a wide range of Laryngoscope, Diagnostic Set and Instruments. We also offer our services to produce any specific instrument for our valued customers

Dedication to Quality

We assure you of superb services and individual attention at all times. Our policy is to achieve excellence through quality performance in meeting our customers' requirements. Throughout the whole production process quality is maintained by watchful in-line supervision and regular and final inspection. Our production units employ the highest quality of raw materials from Pakistan, Germany, France and Japan.

Ligamed is certified by ISO 9001-2008, ISO 13485-2003, ISO 7376, CE Certificate, cGMP & FDA Registered.
These Certificates guarantee that our instruments are safe and fit for their intended use.

Table of Contents

LARYNGOSCOPE

Flexible Tip	1-5
Fiber Optic	6-10
Conventional	11-14
Disposable	15-24
Handle	25-27

DIAGNOSTICS

Otoscopes	28-31
Ophthalmoscopes	32-33
Dermatoscopes	34
ENT Diagnostics Sets	35-38
Packing	39
Instruments	40-41
Accessories	42





Ligamed
Corporation

LED LARYNGOSCOPES

Whiteness
Brightness
Durability



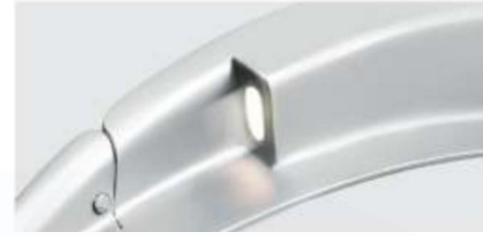

4 x 6 mm MEGA LIGHT



Fiber Optic Handle

FlexibleTip Fiber Optic (F.O.) Laryngoscope Blade MEGA LIGHT

This FlexibleTip Blade is a Macintosh Laryngoscope Blade with a tip which is adjustable through 90°. A lever controls the tip angle during intubation to lift the epiglottis, giving a clear view of the vocal cords. 6500 individual micro-fibers in a 4 X 6 mm Fiber Optic Bundle improve light transmission and longer life.

- :- Outstanding light intensity with LED illumination through extra strong fiber bundle.
- :- Swiveling blade tip facilitates difficult intubation.
- :- Reduced likelihood of damage to teeth and soft tissues.
- :- Reduce the force required to visualize the Larynx.
- :- 303/304 type high grade Stainless Steel with Satin Finish.
- :- Fully autoclavable and easier to clean.
- :- Fiber Optic handle Requires 2 X C size batteries.
- :- According to ISO 7376 Standard.



Back view

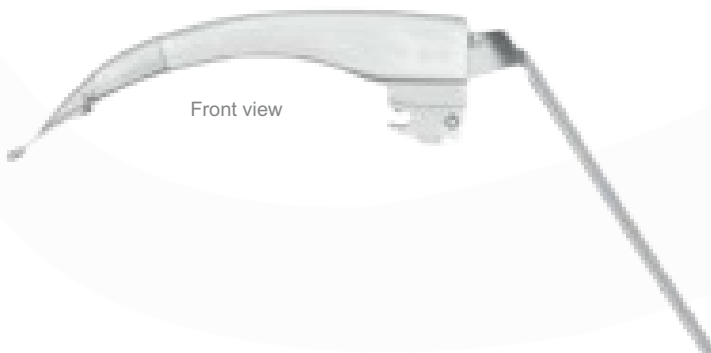

Front view

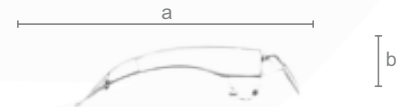

FlexibleTip Fiber Optic (F.O.) Laryngoscope Blade			
Size	Blade	Length	
	Reference no	a {mm}	
1	li-500-01	95	18
2	li-500-02	112	18
3	li-500-03	135	19
4	li-500-04	155	22



Fiber Optic Handle



3 mm FIBER OPTIC LIGHT

FlexibleTip Fiber Optic (F.O.) Laryngoscope Blade FIBER OPTIC LIGHT

This FlexibleTip Blade is a Macintosh Laryngoscope Blade with a tip which is adjustable through 90°. A lever controls the tip angle during intubation to lift the epiglottis, giving a clear view of the vocal cords. 5000 individual micro-fibers in 3 mm Fiber Optic tube improve light transmission and longer life.

- Outstanding light intensity with LED illumination through extra strong fiber bundle
- Swiveling blade tip facilitates difficult intubation.
- Reduced likelihood of damage to teeth and soft tissues.
- Reduce the force required to visualize the Larynx.
- 303/304 type high grade Stainless Steel with Satin Finish.
- Fully autoclavable and easier to clean.
- Fiber Optic handle Requires 2 X C size batteries.
- According to ISO 7376 Standard.



Back view



Front view



FlexibleTip Fiber Optic (F.O.) Laryngoscope Blade

Size	Blade Reference no	Length	
		a (mm)	b (mm)
1	li-505-01	93	19
2	li-505-02	112	19
3	li-505-03	132	22
4	li-505-04	155	24



LED LAMP



Conventional Handle

FlexibleTip Conventional Laryngoscope Blade LED LAMP

The FlexibleTip is a Macintosh Laryngoscope Blade with a tip which is adjustable through 90°. A lever controls the tip angle during intubation to lift the epiglottis, giving a clear view of the vocal cords.

- Outstanding Light Intensity with LED Illumination.
- Swivelling blade tip facilitates difficult intubation.
- Reduced likelihood of damage to teeth and soft tissue
- Rounded tip and smooth edges.
- 303/304 surgical stainless steel with satin finish.
- Fully autoclavable and easier to clean.
- Conventional handle Requires 2 X C size batteries.
- According to ISO 7376 Standard.



Back view



Front view

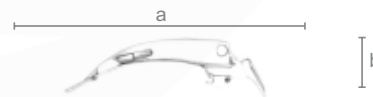

FlexibleTip Conventional Laryngoscope Blade			
Size	Blade Reference.no	Length	
		a {mm}	b {mm}
1	li-510-01	93	19
2	li-510-02	112	19
3	li-510-03	132	22
4	li-510-04	155	24

FLEXIBLETIP, DISPOSABLE, FIBER OPTIC (F.O.) LARYNGOSCOPE



**Ligamed
Corporation**



4 mm LIT LIGHT

FlexibleTip Disposable Fiber Optic (FO.) Laryngoscope Blade

LIT LIGHT

The FlexibleTip is a Macintosh Laryngoscope Blade with a tip which is adjustable through 90°. This blade, with 4 mm plastic end LIT Fiber Optic, is processed from plastic Fiber Optic. We add plastic PVC jacket to protect inner fiber for working well, keep it longer life and get more brightness from Illuminator.

- 304 type high grade Stainless Steel with Plastic Heel, Satin Finish.
- Flexible Fiber optic Tube with black sleeve 5mm LIT Light for improved light transmission.
- Swiveling blade tip facilitates difficult intubation.
- Reduced likelihood of damage to teeth and soft tissues.
- Disposable fiber optic Silver handle with powder coating.
- Disposable handle Requires 3 X Lithium 123 batteries.
- According to ISO 7376 Standard.

Disposable
Fiber Optic Handle



Back view

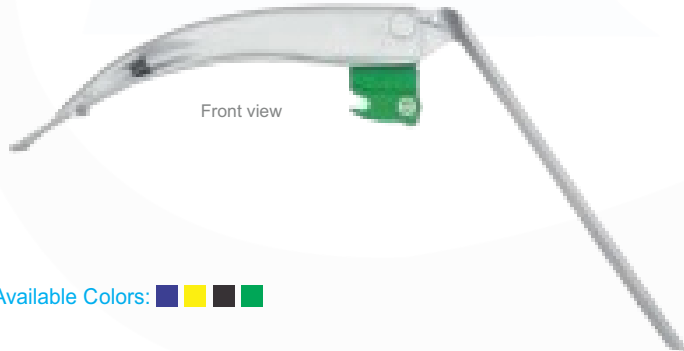

Front view

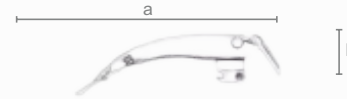

FlexibleTip Disposable Fiber Optic (FO.) Laryngoscope Blade

Size	Blade Reference.no	Length	
		a {mm}	b {mm}
1	li-515-01	100	18
2	li-515-02	113	18
3	li-515-03	135	21
4	li-515-04	155	21

Available Colors:



**Ligamed
Corporation**

FLEXIBLE TIP, DISPOSABLE, CONVENTIONAL LARYNGOSCOPE



3 mm LED LIGHT

FlexibleTip Disposable Conventional Laryngoscope Blade

LED LIGHT

This FlexibleTip Blade is a Macintosh Laryngoscope Blade with a tip which is adjustable through 90°. A lever controls the tip angle during intubation to lift the epiglottis, giving a clear view of the vocal cords.

- Unbreakable Plastic base with Disposable Surgical Stainless Steel blade
- Single use conventional Flexible tip blade with LED light.
- Swiveling blade tip facilitates difficult intubation.
- Reduced likelihood of damage to teeth and soft tissues.
- Reduce the force required to visualize the Larynx.
- Disposable fiber optic Silver handle with powder coating
- Handle Requires 3 X Lithium 123 batteries.
- According to ISO 7376 Standard.

Disposable
Conventional Handle



Back view

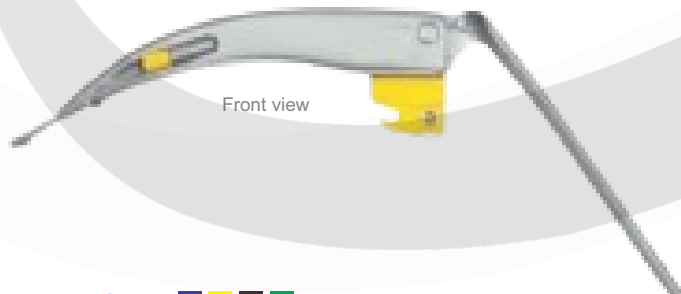

Front view

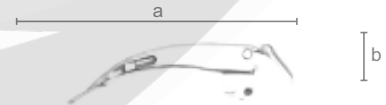

FlexibleTip Disposable Conventional Laryngoscope Blade

Size	Blade Reference.no	Length	
		a {mm}	b {mm}
1	li-520-01	100	18
2	li-520-02	113	18
3	li-520-03	135	21
4	li-520-04	155	21

Available Colors:



Fiber Optic Handle



Fiber Optic (FO.) Laryngoscope Blade MEGA LIGHT

Macintosh Mega Light Laryngoscope blade with 4 x 6 mm and up to 6500 individual micro-fibers for improved light transmission and longer life.

- 303/304 type high grade Stainless Steel with Satin Finish.
- Smooth shape avoids sharp edges and cavities for easy cleaning and sterilizing
- Integrated Fiber Optics for the best possible illumination.
- Compatible with all standard Fiber Optic handles.
- Fully autoclavable and easier to clean.
- Fiber Optic handle with LED light.
- According to ISO 7376 standard.

Power Source

- All our Fiber Optic handles are powered by
 - Standard battery handle: 2" C" size
 - Pediatric battery handle: 2" AA" size
 - Stubby battery handle: 2" AA" size

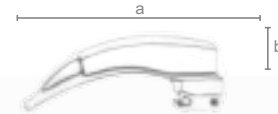

Fiber Optic (FO.) Laryngoscope Blade(Mega Blade)			
Size	Blade	Length	
		a {mm}	b {mm}
1	li-600-01	97	18
2	li-600-02	114	18
3	li-600-03	137	19
4	li-600-04	157	22

Fiber Optic (FO.) Laryngoscope Sets. (Mega Blade)	
Reference no	Description
li-600-10	2 Blades + 1 Handle in Plastic Box.
li-600-20	3 Blades + 1 Handle in Plastic Box.
li-600-30	4 Blades + 1 Handle in Plastic Box.



**Fiber Optic (F.O.) Laryngoscope Blade
INTERCHANGEABLE
LIGHT CONDUCTOR**

Macintosh Fiber Optic laryngoscope blade with 4mm F.O light conductor, up to 6500 individual micro-fibers for improved light transmission and longer life.

- Blade with Removable light conductor which is simple to remove and refit without any tool.
- Integrated Fiber optic for the best Possible Illumination.
- 303/304 type high grade Stainless Steel with Satin Finish.
- Smooth shape avoids sharp edges.
- Fully autoclavable and easier to clean.
- Compatible with all Standard Fiber optic handles.
- Fiber optic Handle with LED light.
- According to ISO 7376 Standard.

Power Source

- All our Fiber Optic handles are powered by
Standard battery handle: 2" C" size
Pediatric battery handle: 2" AA" size
Stubby battery handle: 2" AA" size



Fiber Optic Handle



Macintosh Fiber Optic (F.O.) Laryngoscope Blades (Interchangeable)			
Size	Blade Reference.no	Length	
		a {mm}	b {mm}
1	li-605-01	102	18
2	li-605-02	115	18
3	li-605-03	137	21
4	li-605-04	157	21

Macintosh Fiber Optic (F.O.) Laryngoscope Sets (Interchangeable)	
Reference.no	Description
li-605-10	2 Blades + 1 Handle in Plastic Box.
li-605-20	3 Blades + 1 Handle in Plastic Box.
li-605-30	4 Blades + 1 Handle in Plastic Box.



Fiber Optic Handle



Fiber Optic (F.O.) Laryngoscope Blade

INTERCHANGEABLE LIGHT CONDUCTOR

Miller Fiber Optic laryngoscope blade with 4mm F.O light conductor, up to 6500 individual micro-fibers for improved light transmission and longer life.

- Blade with Removable light conductor which is simple to remove and refit without any tool.
- Integrated Fiber optic for the best Possible Illumination.
- 303/304 type high grade Stainless Steel with Satin Finish.
- Smooth shape avoids sharp edges.
- Fully autoclavable and easier to clean.
- Compatible with all Standard Fiber optic handles.
- Fiber optic Handle with LED light.
- According to ISO 7376 Standard.

Power Source

- All our Fiber Optic handles are powered by Standard battery handle 2 " C " size
- Pediatric battery handle: 2 " AA " size
- Study battery handle: 2 " AA " size

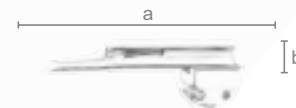

Miller Fiber Optic (F.O.) Laryngoscope Blades.(Interchangeable)

Size	Blade	Length	
		a (mm)	b (mm)
00	li-610-00	70	12
0	li-610-0	78	12
1	li-610-01	105	12
2	li-610-02	155	13
3	li-610-03	195	13
4	li-610-04	204	15

Miller Fiber Optic (F.O.) Laryngoscope Sets.(Inter changeable)

Reference.no	Description
li-610-10	3 Blades + 1 Handle in Plastic Box.
li-610-20	4 Blades + 1 Handle in Plastic Box.
li-610-30	5 Blades + 1 Handle in Plastic Box.



Fiber Optic (F.O.) Laryngoscope Blade FIXTUBE

Macintosh Fiber Optic laryngoscope blade with 4mm FO light conductor, up to 6500 individual micro-fibers for improved light transmission and longer life.

- ❖ Blade with Fixed Fiberoptic light conductor.
- ❖ Integrated Fiber optic for the best Possible Illumination.
- ❖ 303/304 type high grade Stainless Steel with Satin Finish.
- ❖ Smooth shape avoids sharp edges.
- ❖ Fully autoclavable and easier to clean.
- ❖ Compatible with all Standard Fiber optic handles.
- ❖ Fiber optic Handle with LED light.
- ❖ According to ISO 7376 standard.

Power Source

- ❖ All our Fiber Optic handles are powered by Standard battery handle:2" C" size
- ❖ Pediatric battery handle:2" AA" size
- ❖ Stubby battery handle:2" AA" size

Fiber Optic Handle



Macintosh Fiber Optic (F.O.) Laryngoscope Blades.(Fix Tube)

Size	Blade	Length	
		a {mm}	b {mm}
	Reference.no		
1	li-615-01	102	18
2	li-615-02	115	18
3	li-615-03	137	21
4	li-615-04	157	21

Macintosh Fiber Optic (F.O.) Laryngoscope Sets.(Fix Tube)

Reference.no	Description
li-615-10	2 Blades + 1 Handle in Plastic Box.
li-615-20	3 Blades + 1 Handle in Plastic Box.
li-615-30	4 Blades + 1 Handle in Plastic Box.

Fiber Optic (F.O.) Laryngoscope Blade FIXTUBE

Miller Fiber Optic laryngoscope blade with 4mm FO light conductor, up to 6500 individual micro-fibers for improved light transmission and longer life.

- ❖ Blade with Fixed Fiber optic light conductor.
- ❖ Integrated Fiber optic for the best Possible Illumination.
- ❖ 303/304 type high grade Stainless Steel with Satin Finish.
- ❖ Smooth shape avoids sharp edges.
- ❖ Fully autoclavable and easier to clean.
- ❖ Compatible with all Standard Fiber optic handles.
- ❖ Fiber optic Handle with LED light.
- ❖ According to ISO 7376 standard.

Power Source

- ❖ All our Fiber Optic handles are powered by Standard battery handle: 2" C" size
- Pediatric battery handle: 2" AA" size
- Stubby battery handle: 2" AA" size



Fiber Optic Handle

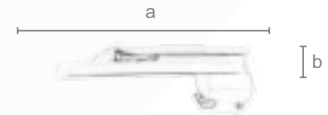
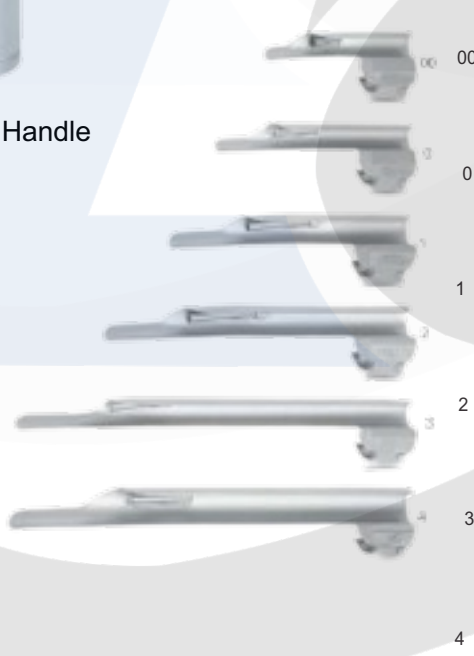

Miller Fiber Optic (F.O.) Laryngoscope Blades.(Fix Tube)			
Size	Blade	Length	
		a (mm)	b (mm)
00	li-220-00	70	12
0	li-620-0	78	12
1	li-620-01	105	12
2	li-620-02	155	13
3	li-620-03	195	13
4	li-620-04	204	15

Miller Fiber Optic (F.O.) Laryngoscope Sets. (Fix Tube)	
Reference.no	Description
li-620-10	3 Blades + 1 Handle in Plastic Box.
li-620-20	4 Blades + 1 Handle in Plastic Box.
li-620-30	5 Blades + 1 Handle in Plastic Box.



Conventional Laryngoscope Blade LED BULB

Macintosh Conventional Laryngoscope Blade with LED Bulb
The light bulb in the blade can easily be changed

- Outstanding light intensity with LED illumination.
- 303/304 type high grade Stainless Steel.
- Satin finish laryngoscope blade reduces glares safe, ensurer intubations
- Smooth knurled Handle provides grip without risk of tearing gloves.
- Fully autoclavable and easier to clean.
- According to ISO 7376 Standard.

Power Source

- All our Conventional handles are powered by
Standard battery handle: 2" C" size
Pediatric battery handle: 2" AA" size
Stubby battery handle: 2" AA" size

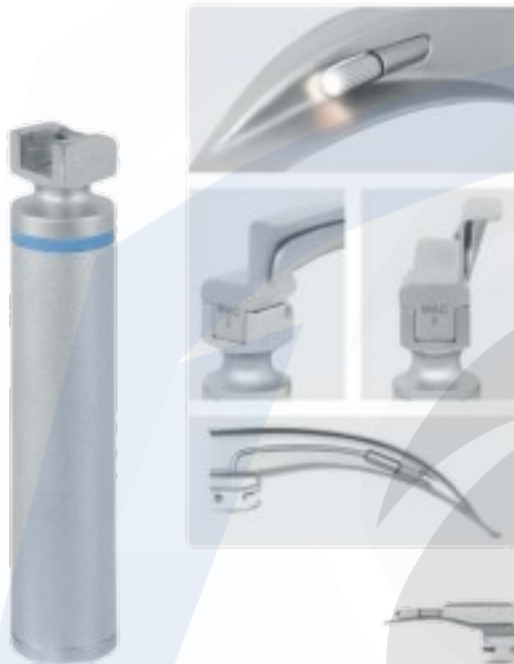

Conventional Handle

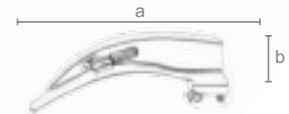

Macintosh Conventional Laryngoscope Blades.

Size	Blade	Length	
		a (mm)	b (mm)
	Reference.no		
0	li-625-0	82	17
1	li-625-1	95	19
2	li-625-02	114	19
3	li-625-03	134	22
4	li-625-04	157	24
5	li-625-05	177	24

Macintosh Conventional Laryngoscope Sets.

Reference.no	Description
li-625-10	3 Blades + 1 Handle in Plastic Box.
li-625-20	4 Blades + 1 Handle in Plastic Box.
li-625-30	5 Blades + 1 Handle in Plastic Box.

Conventional Laryngoscope Blade LED BULB

Miller Conventional Laryngoscope Blade with LED Bulb
The light bulb in the blade can easily be changed

- ❖ Outstanding light intensity with LED illumination.
- ❖ 303/304 type high grade Stainless Steel.
- ❖ Satin finish laryngoscope blade reduces glares safe, ensurer intubations
- ❖ Smooth knurled Handle provides grip without slippages.
- ❖ Fully autoclavable and easier to clean.
- ❖ According to ISO 7376 Standard.

Power Source

- ❖ All our Conventional handles are powered by
 - Standard battery handle: 2" C "size
 - Pediatric battery handle: 2" AA" size
 - Stubby battery handle: 2" AA" size



Conventional Handle



Miller Conventional Laryngoscope Blades.

Size	Blade Reference.no	Length	
		a (mm)	b (mm)
00	li-630-00	70	12
0	li-630-0	78	12
1	li-630-01	105	12
2	li-630-02	155	13
3	li-630-03	195	13
4	li-630-04	204	15

Miller Conventional Laryngoscope Sets.

Reference.no	Description
li-630-10	3 Blades + 1 Handle in Plastic Box.
li-630-20	4 Blades + 1 Handle in Plastic Bo
li-630-30	5 Blades + 1 Handle in Plastic Bo



**Conventional Laryngoscope Blade
FIXED LED LAMP**

Macintosh Conventional Laryngoscope blade with FIXED LED lamp
The light lamp is fixed in the tube and non-changeable

- Outstanding light intensity with LED illumination.
- 303/304 type high grade Stainless Steel.
- Satin finish laryngoscope blade reduces glares safe, ensurer intubations
- Smooth knurled Handle provides grip without risk of tearing gloves.
- Fully autoclavable and easier to clean.
- According to ISO 7376 Standard.

Power Source

- All our Conventional handles are powered by
Standard battery handle:2" C "size
Pediatric battery handle:2" AA" size
Stubby battery handle:2" AA" size



Conventional Handle



Macintosh Conventional Laryngoscope Blade with fixed LED lamp			
Size	Blade Reference.no	Length	
		a {mm}	b {mm}
1	li-635-01	102	18
2	li-635-02	115	18
3	li-635-03	137	21
4	li-635-04	157	21

Macintosh Conventional Laryngoscope Sets with fixed LED lamp	
Reference.no	Description
li-635-10	2 Blades + 1 Handle in Plastic Box.
li-635-20	3 Blades + 1 Handle in Plastic Box.
li-635-30	4 Blades + 1 Handle in Plastic Box.



Conventional Laryngoscope Blade FIXED LED LAMP

Miller Conventional Laryngoscope blade with FIXED LED lamp
The light lamp is fixed in the tube and non-changeable

- Outstanding light intensity with LED illumination.
- 303/304 type high grade Stainless Steel.
- Satin finish laryngoscope blade reduces glare safe, ensuring intubation.
- Smooth knurled Handle provides grip without risk of tearing gloves.
- Fully autoclavable and easier to clean.
- According to ISO 7376 Standard.

Power Source

- All our Conventional handles are powered by
 - Standard battery handle: 2" C" size
 - Pediatric battery handle: 2" AA" size
 - Stubby battery handle: 2" AA" size



Conventional Handle

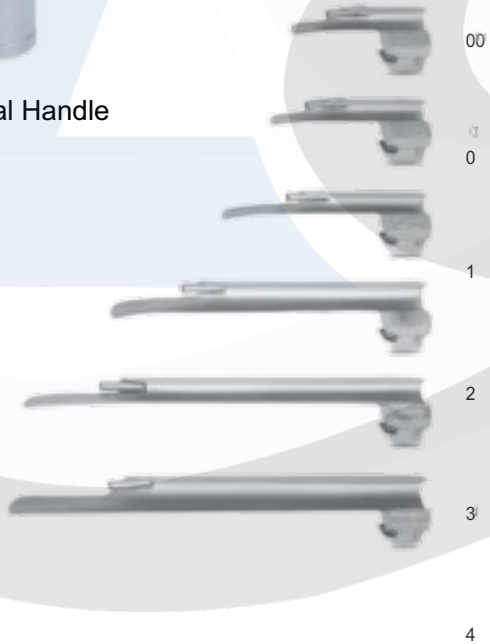
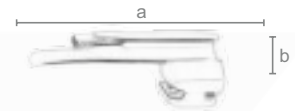

Miller Conventional Laryngoscope Blade with fixed LED lamp

Size	Blade Reference.no	Length	
		a (mm)	b (mm)
00	li-640-00	70	12
0	li-640-0	78	12
1	li-640-01	105	12
2	li-640-02	155	13
3	li-640-03	195	13
4	li-640-04	204	15

Miller Conventional Laryngoscope Sets with fixed LED lamp

Reference.no	Description
li-640-10	3 Blades + 1 Handle in Plastic Box.
li-640-20	4 Blades + 1 Handle in Plastic Box.
li-640-30	5 Blades + 1 Handle in Plastic Box.



**Ligamed
Corporation**

MACINTOSH, DISPOSABLE, CONVENTIONAL LARYNGOSCOPE



Dual Lighted Conventional Laryngoscope Blade UV/WHITE LED

Plastic Heel

White and UV LED lighting combination produces optimized high definition viewing area,

- ❖ Blade made of 304 type non-magnet stainless steel with plastic heel.
- ❖ Smooth shape avoids sharp edges and cavities.
- ❖ Compatible with all standard conventional handles.
- ❖ Conventional disposable handle made of silver.
- ❖ According to ISO 7376 standard.

Power Source

- ❖ Watch-size lithium batteries are pre-installed for quick single use and are easily removed for separate disposal. These Fiber Optic disposable handles will illuminate blades for up to 5 hours.



Disposable
Conventional Handle

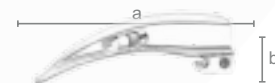
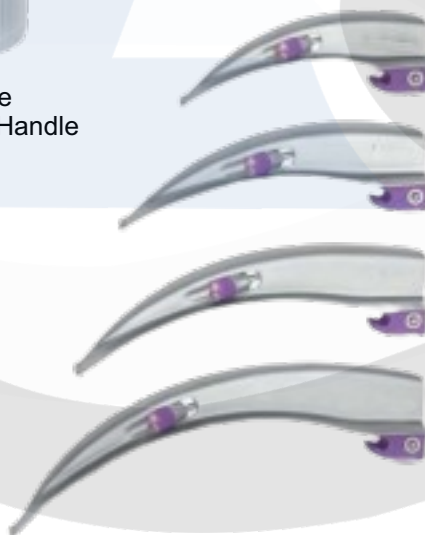

Macintosh Disposable Conventional Laryngoscope Blade

Size	Blade	Length	
		a {mm}	b {mm}
1	li-700-01	102	18
2	li-700-02	115	18
3	li-700-03	137	21
4	li-700-04	157	21

Macintosh Disposable Conventional Laryngoscope Sets.

Reference.no	Description
li-700-10	2 Blades + 1 Handle in Plastic Box.
li-700-20	3 Blades + 1 Handle in Plastic Box.
li-700-30	4 Blades + 1 Handle in Plastic Box.



Dual Lighted Conventional Laryngoscope Blade UV/WHITE LED

Plastic Heel

White and UV LED lighting combination produces optimized high definition viewing area,

- Blade made of 304 type non-magnet stainless steel with plastic heel.
- Smooth shape avoids sharp edges and cavities.
- Compatible with all standard conventional handles.
- Conventional disposable handle made of silver, with LED light.
- According to ISO 7376 standard.

Power Source

- Watch-size lithium batteries are pre-installed for quick single use and are easily removed for separate disposal. These Fiber Optic disposable handles will illuminate blades for up to 5 hours.

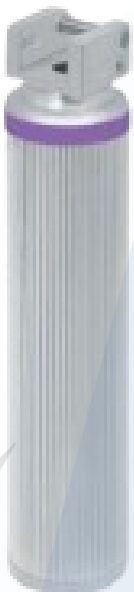

Disposable Conventional Handle

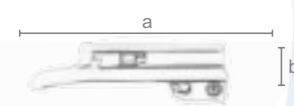

Miller Disposable Conventional Laryngoscope Blade			
Size	Blade	Length	
	Reference.no	a {mm}	b {mm}
00	li-705-00	66	11
0	li-705-0	76	11
1	li-705-01	104	11
2	li-705-02	155	14
3	li-705-03	195	14
4	li-705-04	205	14

Miller Disposable Conventional Laryngoscope Sets.	
Reference.no	Description
li-705-10	3 Blades + 1 Handle in Plastic Box.
li-705-20	4 Blades + 1 Handle in Plastic Box.
li-705-30	5 Blades + 1 Handle in Plastic Box.



**Ligamed
Corporation**

MACINTOSH, DISPOSABLE, FIBER OPTIC (F.O.) LARYNGOSCOPE



Fiber Optic (F.O.) Laryngoscope Blade BLACK JACKET LIT LIGHT Stainless Steel Heel

Disposable Macintosh Laryngoscope blade with 4 mm plastic end LIT Fiber Optic, it is processed from plastic Fiber Optic. We coat a plastic PVC jacket to protect inner fiber, working well keep it longer life and get more brightness from Illuminator.

- ❖ Blade made of 303/304 type non-magnet stainless steel.
- ❖ Smooth shape avoids sharp edges and cavities.
- ❖ Fiber Optic handle with LED light.
- ❖ Compatible with all standard Fiber Optic handles.
- ❖ Smooth ruffled Handle provides grip without risk of tearing gloves.
- ❖ According to ISO 7376 standard.

Power Source

- ❖ All our Fiber Optic handles are powered by
 - Standard battery handle: 2" C " size
 - Pediatric battery handle: 2" AA" size
 - Stubby battery handle: 2" AA" size



Fiber Optic Handle

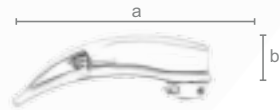

Macintosh Disposable Fiber Optic (F.O.) Laryngoscope Blade			
Size	Blade	Length	
	Reference no	a (mm)	b (mm)
1	li-710-01	102	18
2	li-710-02	115	18
3	li-710-03	137	21
4	li-710-04	157	21

Macintosh Disposable Fiber Optic (F.O.) Laryngoscope Sets.	
Reference no	Description
li-710-10	2 Blades + 1 Handle in Plastic Box.
li-710-20	3 Blades + 1 Handle in Plastic Box.
li-710-30	4 Blades + 1 Handle in Plastic Box.



Fiber Optic (FO.) Laryngoscope Blade
BLACK JACKET LIT LIGHT
 Silver Heel

Disposable Macintosh Laryngoscope blade with 4 mm plastic end lit Fiber Optic, it is processed from plastic Fiber Optic. We coat a plastic PVC jacket to protect inner fiber, working well keep it longer life and get more brightness from Illuminator.

- ❖ Blade made of 304 type non-magnet stainless steel with silver heel.
- ❖ Smooth shape avoids sharp edges and cavities.
- ❖ Disposable fiber Optic handle made of silver and powder coated with LED light.
- ❖ Compatible with all standard Fiber Optic handles.
- ❖ According to ISO 7376 standard.

Power Source

- ❖ Watch-size lithium batteries are pre-installed for quick, single use and are easily removed for separate disposal. These Fiber Optic disposable handles will illuminate blades for up to 5 hours.

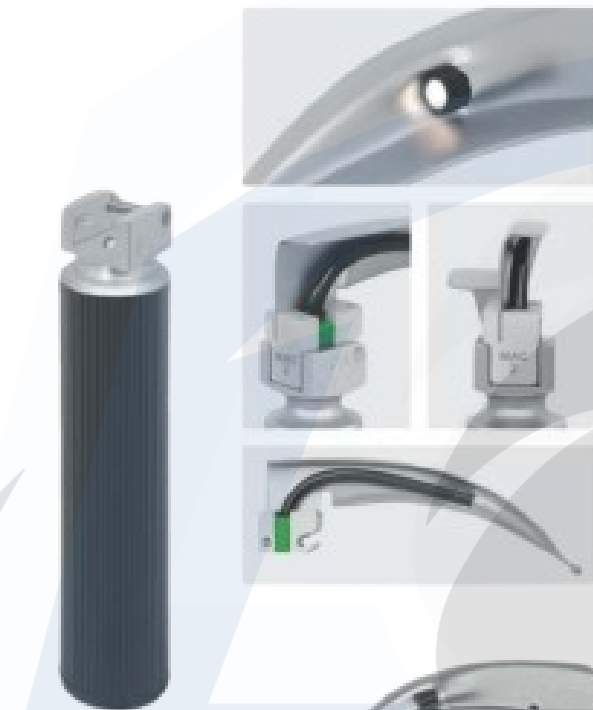

Disposable Fiber Optic Handle



Macintosh Disposable Fiber Optic (FO.) Laryngoscope Blade			
Size	Blade	Length	
	Reference.no	a {mm}	b {mm}
1	li-715-01	102	18
2	li-715-02	115	18
3	li-715-03	137	21
4	li-715-04	157	21

Macintosh Disposable Fiber Optic (FO.) Laryngoscope Sets.	
Reference.no	Description
li-715-10	2 Blades + 1 Handle in Plastic Box.
li-715-20	3 Blades + 1 Handle in Plastic Box.
li-715-30	4 Blades + 1 Handle in Plastic Box.



**Ligamed
Corporation**

MACINTOSH, DISPOSABLE, FIBER OPTIC (F.O.) LARYNGOSCOPE



Fiber Optic (FO.) Laryngoscope Blade

BLACK JACKET LIT LIGHT Plastic Heel

Disposable Macintosh Laryngoscope blade with 4 mm plastic end lit Fiber Optic, it is processed from plastic Fiber Optic. We coat a plastic PVC jacket to protect inner fiber, working well keep it longer life and get more brightness black jacketed from Illuminator.

- ❖ Blade made of 304 type non-magnet stainless steel with plastic heel.
- ❖ Smooth shape avoids sharp edges and cavities.
- ❖ Compatible with all standard Fiber Optic handles.
- ❖ Disposable fiber Optic handle, made of silver, with LED light.
- ❖ According to ISO 7376 standard.

Power Source

- ❖ Watch-size lithium batteries are pre-installed for quick single use and are easily removed for separate disposal. These Fiber Optic disposable handles will illuminate blades for up to 5 hours.

Available Colors:



Disposable
Fiber Optic Handle

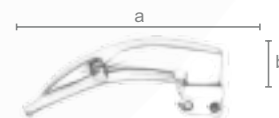

Macintosh Disposable Fiber Optic (FO.) Laryngoscope Blade

Size	Blade Reference.no	Length	
		a (mm)	b (mm)
1	li-720-01	102	18
2	li-720-02	115	18
3	li-720-03	137	21
4	li-720-04	157	21

Macintosh Disposable Fiber Optic (FO.) Laryngoscope Sets.

Reference.no	Description
li-720-10	2 Blades + 1 Handle in Plastic Box.
li-720-20	3 Blades + 1 Handle in Plastic Box.
li-720-30	4 Blades + 1 Handle in Plastic Box.



Fiber Optic (FO.) Laryngoscope Blade BLACK JACKET LIT LIGHT Plastic Heel

Disposable Miller Laryngoscope blade with 4 mm plastic end lit Fiber Optic, it is processed from plastic Fiber Optic. We coat a plastic PVC jacket to protect inner fiber, working well keep it longer life and get more brightness black jacketed from Illuminator.

- Blade made of 304 type non-magnet stainless steel with plastic heel.
- Smooth shape avoids sharp edges and cavities.
- Compatible with all standard Fiber Optic handles.
- Disposable fiber Optic handle, made of silver, with LED light.
- According to ISO 7376 standard.

Power Source

- Watch-size lithium batteries are pre-installed for quick single use and are easily removed for separate disposal. These Fiber Optic disposable handles will illuminate blades for up to 5 hours.

Available Colors:

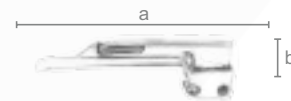

Disposable Fiber Optic Handle



Miller Disposable Fiber Optic (FO.) Laryngoscope Blade

Size	Blade	Length	
		a (mm)	b (mm)
00	li-725-00	66	11
0	li-725-0	76	11
1	li-725-01	104	11
2	li-725-02	155	14
3	li-725-03	195	14
4	li-725-04	205	14

Miller Disposable Fiber Optic (FO.) Laryngoscope Sets.

Reference no	Description
li-725-10	3 Blades + 1 Handle in Plastic Box.
li-725-20	4 Blades + 1 Handle in Plastic Box.
li-725-30	5 Blades + 1 Handle in Plastic Box.



**Ligamed
Corporation**

MACINTOSH, DISPOSABLE, FIBER OPTIC (F.O.) LARYNGOSCOPE



Disposable Fiber Optic (FO.) Laryngoscope Blade F.O. ACRYLIC ROD

Silver Heel

Macintosh Single-Use Fiber Optic Blade with 5mm diameter acrylic rod for improved light transmission.

- Blade made of 304 type non-magnet stainless steel with silver heel.
- Smooth shape avoids sharp edges and cavities.
- Fiber Optic handle, made of silver, with LED light.
- Compatible with all standard Fiber Optic handles.
- According to ISO 7376 standard.

Power Source

- Watch-size lithium batteries are pre-installed for quick single use and are easily removed for separate disposal. These Fiber Optic disposable handles will illuminate blades for up to 5 hours.

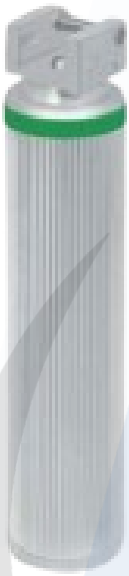

Disposable
Fiber Optic Handle

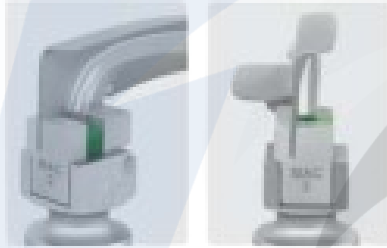

Macintosh Disposable Fiber Optic (FO.) Laryngoscope Blade			
Size	Blade	Length	
	Reference.no	a {mm}	b {mm}
1	li-730-01	102	18
2	li-700-02	115	18
3	li-700-03	137	21
4	li-700-04	157	21

Macintosh Disposable Fiber Optic (FO.) Laryngoscope Sets.	
Reference.no	Description
li-700-10	2 Blades + 1 Handle in Plastic Box.
li-700-20	3 Blades + 1 Handle in Plastic Box.
li-700-30	4 Blades + 1 Handle in Plastic Box.



Disposable Fiber Optic (FO.) Laryngoscope Blade

F.O. ACRYLIC ROD

Plastic Heel

Macintosh Single-Use Fiber Optic Blade with 5mm diameter acrylic rod for light transmission.

- ❖ Blade made of 304 type non-magnet stainless steel with plastic heel.
- ❖ Smooth shape avoids sharp edges and cavities.
- ❖ Fiber Optic handle, made of silver, with LED light.
- ❖ Compatible with all standard Fiber Optic handles.
- ❖ According to ISO 7376 standard.

Power Source

- ❖ Watch-size lithium batteries are pre-installed for quick, single use and are easily removed for separate disposal. These Fiber Optic disposable handles will illuminate blades for up to 5 hours.

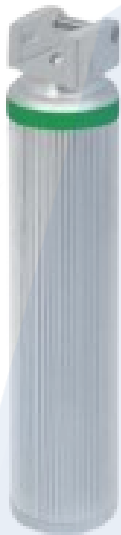

Disposable Fiber Optic Handle

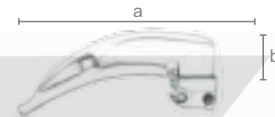
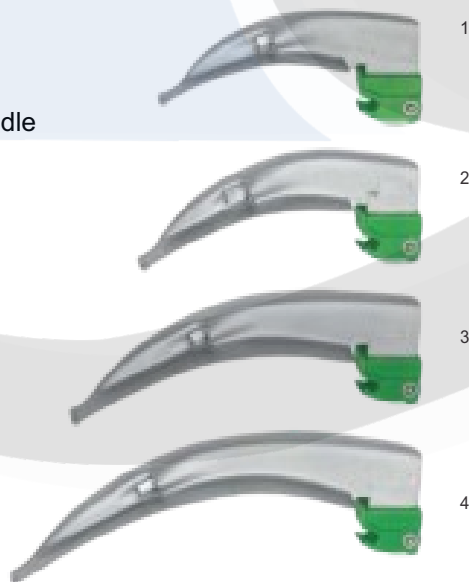

Macintosh Disposable Fiber Optic (FO.) Laryngoscope Blade			
Size	Blade	Length	
	Reference.no	a (mm)	b (mm)
1	li-735-01	102	18
2	li-735-02	115	18
3	li-735-03	137	21
4	li-735-04	157	21

Macintosh Disposable Fiber Optic (FO.) Laryngoscope Sets.	
Reference.no	Description
li-735-10	2 Blades + 1 Handle in Plastic Box.
li-735-20	3 Blades + 1 Handle in Plastic Box.
li-735-30	4 Blades + 1 Handle in Plastic Box.



Ligamed Corporation

MILLER, DISPOSABLE, FIBER OPTIC (FO.) LARYNGOSCOPE



Disposable Fiber Optic (FO.) Laryngoscope Blade F.O. ACRYLIC ROD

Plastic Heel

Miller Single-Use Fiber Optic Blade with 5mm diameter acrylic rod for improved light transmission.

- Blade made of 304 type non-magnet stainless steel with plastic heel.
- Smooth shape avoids sharp edges and cavities.
- Fiber Optic handle, made of silver, with LED light.
- Compatible with all standard Fiber Optic handles.
- According to ISO 7376 standard.

Power Source

- Watch-size lithium batteries are pre-installed for quick single use and are easily removed for separate disposal. These Fiber Optic disposable handles will illuminate blades for up to 5 hours.

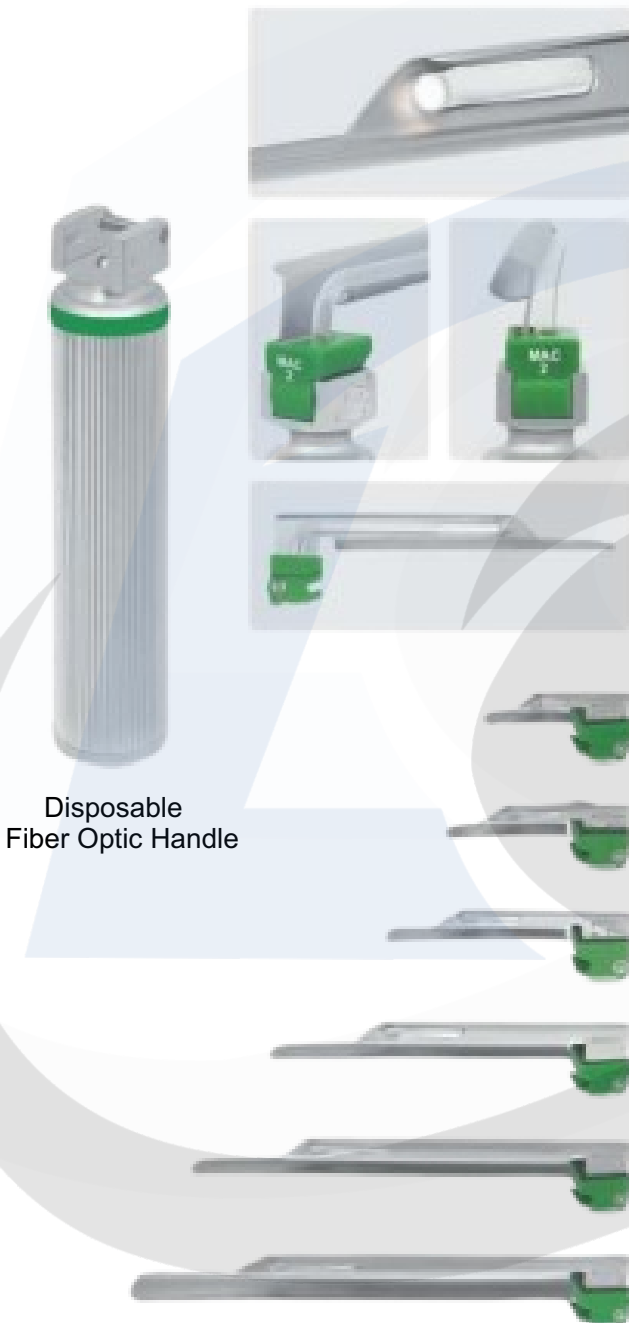

Disposable Fiber Optic Handle

Miller Disposable Fiber Optic (FO.) Laryngoscope Blade

Size	Blade	Length	
	Reference no	a {mm}	b {mm}
00	li-740-00	66	11
0	li-740-0	76	11
1	li-740-01	104	11
2	li-740-02	155	14
3	li-740-03	195	14
4	li-740-04	205	14

Miller Disposable Fiber Optic (FO.) Laryngoscope Sets.

Reference.no	Description
li-740-10	3 Blades + 1 Handle in Plastic Box.
li-740-20	4 Blades + 1 Handle in Plastic Box.
li-740-30	5 Blades + 1 Handle in Plastic Box.



Conventional Laryngoscope Blade LED LIGHT

Plastic Heel

Macintosh Single-Use Conventional Blade with LED light plastic heel and disposable handle.

- Blade made of 304 type non-magnet stainless steel with plastic heel.
- Smooth shape avoids sharp edges and cavities.
- Compatible with all standard Conventional handles.
- Conventional handle, made of silver with powder coating.
- According to ISO 7376 standard.

Power Source

- Watch-size lithium batteries are pre-installed for quick single use and are easily removed for separate disposal. These Fiber Optic disposable handles will illuminate blades for up to 5 hours.

Available Colors:



Disposable Conventional Handle



1

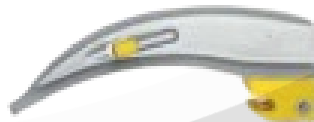

2



3



4



Disposable Conventional Laryngoscope Blade			
Size	Blade	Length	
		a {mm}	b {mm}
1	li-745-01	102	18
2	li-745-02	115	18
3	li-745-03	137	21
4	li-745-04	157	21

Disposable Conventional Laryngoscope Sets.	
Reference.no	Description
li-745-10	2 Blades + 1 Handle in Plastic Box.
li-745-20	3 Blades + 1 Handle in Plastic Box.
li-745-30	4 Blades + 1 Handle in Plastic Box.



Fiber Optic (F.O.) Laryngoscope Handles

- ❖ Complies with ISO 7376 Green standard.
- ❖ Premium Handles & LED lamp have a lifetime warranty.
- ❖ Low power use prolongs battery life.
- ❖ Cool, white illumination improves view of larynx.
- ❖ Knurled Finish for secure & positive grip.
- ❖ Batteries not included

Fiber Optic Laryngoscope Handles

Reference.no	Size	Batteries
li-800-10	Large	2 x " D "
li-800-20	Medium/Standard	2 x " C "
li-800-30	Small/Pen light	2 x " AA "
li-800-40	Stubby	2 x " AA "
li-800-50	Micro	Lithium 123



Conventional Laryngoscope Handles

- ❖ Complies with ISO 7376 Green standard.
- ❖ Premium Handles have a lifetime warranty.
- ❖ Low power use prolongs battery life.
- ❖ Cool, white illumination improves view of larynx.
- ❖ Knurled Finish for secure & positive grip
- ❖ Batteries not included

Conventional Laryngoscope Handles		
Reference.no	Size	Batteries
li-810-10	Large	2 x " D "
li-810-20	Medium/Standard	2 x " C "
li-810-30	Small/Pen light	2 x " AA "
li-810-40	Stubby	2 x " AA "
li-810-50	Micro	Lithium 123



Fiber Optic

Conventional

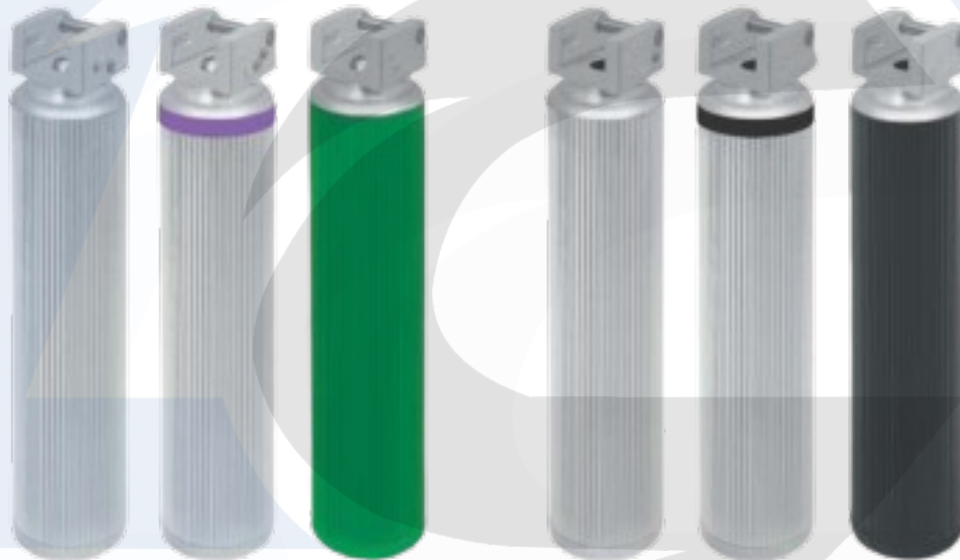

Disposable Fiber Optic (F.O.) Laryngoscope Handles

- ❖ Made of silver, available with & without powder coating.
- ❖ With LED bulb
- ❖ Low power use prolongs battery life.
- ❖ Cool, white illumination improves view of larynx.
- ❖ Knurled Finish for secure & positive grip
- ❖ Batteries are included
- ❖ Complies with ISO 7376 Green standard.

Disposable Fiber Optic Laryngoscope Handles		
Reference.no	Size	Batteries
li-820-10	Standard	3 X Lithiumf 123 "
li-820-20	Standard	3 X Lithiumf 123 "
li-820-30	Standard	3 X Lithiumf123 "

Disposable Conventional Laryngoscope Handles

- ❖ Made of silver, available with & without powder coating.
- ❖ Low power use prolongs battery life.
- ❖ Knurled Finish for secure & positive grip
- ❖ Batteries are included
- ❖ Complies with ISO 7376 Green standard.

Disposable Conventional Laryngoscope Handles		
Reference.no	Size	Batteries
li-830-10	Standard	2 X Lithiumf 123 "
li-830-20	Standard	2 X Lithiumf 123 "
li-830-30	Standard	2 X Lithiumf 123 "

Available Colors:



Ligamed
Corporation

ENT PRODUCT SECTION

Diagnostic Sets
Instruments
Accessories





SI-500-10

Fiber Optic (Pocket Style)

2.5v LED

High Quality pocket sized Mini Fiber Optic Otoscope with extra bright light with 3x magnification lens. Distal Fiber Optic illumination 4mm bundle with Enhanced LED technology.

Attachment clip with integrated on/o fswitch.

Power Supply 2x AA Batteries (not included in set).

Packing: In Gray or Black pouch with 10 disposable Specula Dia 2.5mm & 4.0 mm

Available Colours: ■ ■ ■ ■



SI-500-20

Fiber Optical (Pocket Style)

2.5v LED

Modern pocket otoscope compact design. Handy and powerful. Distal Fiber-Optic (FO.) illumination 4mm bundle with Enhanced LED Technology.

Attachment clip with integrated on/o fswitch.

Power Supply: 2x AA Batteries (not included in set).

Packing: In Gray or Black pouch with 10 disposable Specula Dia 2.5mm & 4.0 mm

Available Colours: ■ ■ ■ ■



METAL OTOSCOPES



Ligamed
Corporation



SI-500-30

Fiber Optic (Metal Otoscope)

2.5v LED

Equipped with an easy to use Bayonet connecting system with high quality professional metal head. Chrome plated knurled battery handle makes surface, a secure grip in the hand. Extra bright light of 2.5v LED bulb illumination provided through Fiber Optic system.

3 X High Quality magnifying Lens.

Power Supply 2x AA Batteries (not included in set).

Packing: In Gray or Black pouch / plastic box with 10 disposable Specula Dia 2.5mm & 4.0 mm



SI-500-40

Conventional (Plastic Head Otoscope)

2.5v LED

Equipped with an easy to use Bayonet connecting system with high quality plastic head. Chrome plated knurled battery handle makes surface, a secure grip in the hand. Extra bright light of 2.5v LED bulb illumination.

3 X High Quality magnifying Lens.

Power Supply: 2x AA Batteries (not included in set).

Packing: In Gray or Black pouch / plastic box with 10 disposable Specula Dia 2.5mm & 4.0 mm





**Ligamed
Corporation**

METAL OTOSCOPIES



SI-500-50

Conventional (Parker Metal Otoscope)

2.5v LED

High quality professional Parker Otoscope with extra bright light.
2.5v LED illumination with 3 X magnifying lens

Available in Satin and Polish Finish.

Power Supply: 2 x AA Batteries (not included in set).

Packing: In Gray or Black pouch / plastic box with 10 disposable Specula Dia
2.5mm & 4.0 mm



SI-500-60

Conventional (Metal Otoscope)

2.5v LED

Standard metal otoscope with bayonet connecting head fitting. Ideal for
pneumatic tympanic membrane test and every day ENT use
2.5 v LED white Light.

Available in Satin & polish Finish.

Power Supply: 2 x AA Batteries (not included in set).

Packing: In Gray or Black pouch / plastic box with 10 disposable Specula Dia
2.5mm & 4.0 mm





SI-500-70

Conventional (Veterinary Metal Otoscope)

2.5v LED

Open system with rotatable lens and optional speculum for convenient procedures. 2.5v LED illumination. Knurled handle with a beautiful satin finish.

Power Supply: 2 x AA Batteries (not included in set).

Packing: In Gray or Black pouch / plastic box with 3Vet reusable Specula Dia 4.0,5.0,7.0 mm



SI-500-80

Conventional (Veterinary Metal Otoscope)

2.5v LED

Bayonet locking otoscope head with 3x magnifying lens. 2.5V Led Illumination. Knurled handle with a beautiful satin finish.

Power Supply: 2 x AA Batteries (not included in set).

Packing: In Gray or Black pouch / plastic box with 3Vet reusable Specula Dia 4.0,5.0,7.0 mm





The ophthalmoscope is a tool used in medical to examine the interior of the eye. Studying the inner parts of the eye, such as the optic disk, retinal blood vessels, retina, choroid and macula, can help diagnose diseases of the eye.

SI-600-10

(Pocket Ophthalmoscope)

The Pocket size Ophthalmoscope is a light weight, compact diagnostic instrument that delivers high performance in a slightly smaller package. Quality optics in mini-format is ideal for rounds and house calls. Attachment clip with integrated on/off switch. High-quality plastic handle with shock proof, sturdy, non-slip features. Enhanced LED Technology for perfect illumination and a brilliant image 4 different apertures. Comprehensive lens range from + 20 D to -20 D.

Power Supply: 2 x AA Batteries (not included in set).
Packing: Hard plastic case packing.



SI-600-20

(Ophthalmoscope)

2.5v LED lamp light for true tissue color and consistent long lasting illumination 16 color coded lenses -25 to +25 for excellent resolution (Red for - Black for +) 4 different apertures (small, large, blue, half moon focus) Rubber eye brow rest to prevent scratching of eye-glasses illumination lens dial for clear identification of diopter setting

Power Supply: 2 x AA Batteries (not included in set).
Packing: Hard plastic case packing.





SI-600-30

(Ophthalmoscope)

Parker mini Ophthalmoscope with 2.5v LED bulb light for true tissue color and consistent long lasting illumination 24 color coded lenses - 25 to + 40 for excellent resolution (Red for - Green for +) Rubber eye brow rest to prevent scratching of eye-glasses illumination lens dial for clear identification for adopter setting.

Power Supply: 2 x AA Batteries (not included in set).
Packing: Hard plastic case packing.



SI-600-40

(Ophthalmoscope)

Parker mini Ophthalmoscope with 2.5v LED bulb light for true tissue color and consistent long lasting illumination 24 color coded lenses - 25 to + 40 for excellent resolution (Red for - Green for +) Rubber eye brow rest to prevent scratching of eye-glasses illumination lens dial for clear identification for adopter setting

Power Supply: 2 x C Batteries (not included in set).
Packing: Hard plastic case packing.



SI-700-10

(Dermatoscope)

Modern pocket Dermatoscope in a compact design with high-quality optics 10X magnification. large, high-resolution image. Choice of two skin-friendly and sterilizable contact plates: with scale from 0 - 10mm for exact measurement of pigmented skin lesions, without scale. Simple lamp change on the underside of the instruments head. Enhanced LED Technology for more light. Attachment clip with integrated On/Off switch. High-quality 2 color handle.

Power Supply: 2 x AA Batteries (not included in set).
Packing: Hard plastic case packing.

SI-700-20

(Dermatoscope)

Bayonet locking system for easy engagement and disengagement from the handle. 2.5v LED illumination of the examination field. High resolution achromatic lenses system with 10x magnification. Adjustable eyepiece for large correction range. Lens without scale. Soft eyepiece protection.

Available in Polish and Sand finish.

Power Supply: 2 x C Batteries (not included in set).
Packing: Hard plastic case packing.





SI-800-10

**Fiber Optic
(ENT DIAGNOSTIC SET LARGE)**

An ENT diagnostic set consists of different ENT tools that are used in the examination of the ears, nose and throat. Our Fiber Optic Diagnostic Set consists of following.

Handle for Otoscope and Ophthalmoscope with Bayonet Connection System.
2.5V Led Otoscope Head.

1 Ophthalmoscope, 3 reusable ear specula, 1 Curved Illuminator
2 Laryngeal Mirrors, 1 Tongue Depressor Support for disposable tongue depressor
1 adjustable nasal speculum fitting., 20 pcs (2.5mm & 4.0mm, 10 each) of mini specula packed in transparent bottle. 2 spare LED bulb

Power Supply: 2 x C Batteries (not included in set).

Packing: light weight zipper case.



SI-800-20

**Conventional
(ENT DIAGNOSTIC SET)**

Handle for Otoscope and Ophthalmoscope with Bayonet Connection System.
2.5V Led Otoscope Head.

1 Ophthalmoscope, 3 reusable ear specula, 1 Curved Illuminator
2 Laryngeal Mirrors, 1 Tongue Depressor Support for disposable tongue depressor, 1 adjustable nasal speculum fitting., 2 spare LED bulb

Power Supply: 2 x C Batteries (not included in set).

Packing: Hard plastic case packing.



SI-800-30

(ENT DIAGNOSTIC SET LARGE)

Handle for Otoscope and Ophthalmoscope with Bayonet Connection System.
2.5V Led Otoscope Head.
1 Ophthalmoscope, 3 reusable ear specula, 1 Curved Illuminator
2 Laryngeal Mirrors, 1 Tongue Depressor Support for disposable tongue depressor, 1 adjustable nasal speculum fitting., 2 spare LED bulb

Power Supply: 2 x C Batteries (not included in set).
Packing: Hard plastic case packing.



SI-800-40

(ENT DIAGNOSTIC SET)

Handle for Otoscope and Ophthalmoscope with screw locking System.
2.5V Led Otoscope Head.
1 Ophthalmoscope, 3 reusable ear specula, 1 Curved Illuminator
2 Laryngeal Mirrors, 1 Tongue Depressor Support for disposable tongue depressor, 1 adjustable nasal speculum fitting., 2 spare LED bulb

Power Supply: 2 x C Batteries (not included in set).
Packing: Hard plastic case packing.



SI-800-50

Fiber Optic (ENT DIAGNOSTIC SET)

Handle for Otoscope and Ophthalmoscope with Bayonet Connection System.
Fiber Optic Otoscope Head
1 Ophthalmoscope, 3 reusable ear specula,
10 pcs (2.5mm & 4.0mm,5 each) of mini specula packed in transparent bottle.
2 spare LED bulb

Power Supply:2 x C Batteries (not included in set).
Packing:light weight zipper.case

SI-800-60

Fiber Optic (ENT DIAGNOSTIC SET)

Parker Diagnostic set Small
Handle for Otoscope and Ophthalmoscope with Bayonet Connection System.
Fiber Optic Otoscope Head.
1 Ophthalmoscope,
10 pcs (2.5mm & 4.0mm,5 each) of mini specula packed in transparent bottle.
2 spare LED bulb

Power Supply:2 x C Batteries (not included in set).
Packing:light weight zipper.case



SI-800-70

(VETERINARY DIAGNOSTIC SET)

- Open system with rotatable lens and optional speculum for convenient procedures. otoscope for long-lasting performance
LED bulb technology for super view with 3 reusable ear speculum \varnothing 4.0 / 5.0 / 7.0 mm
- Nasal speculum, easy adjustable with finger clip
- 3 inch Micro alligator Forceps

Requires: 2 x C batteries (not included with set)

Supply: Hard case packing



SI-900-01
Laryngoscope Bottle



Available in Different Colors



Soft Zipper Pouch
Metal Otoscope / Dermatoscope
Available in Different Colors

Black



SI-900-05
Laryngoscope Zipper Box



White

SI-900-04
Hard plastic Case
Dermatoscope / Otoscope



SI-900-06
Laryngoscope Plastic Box



Ligamed
Corporation

PERCUSSION HAMMERS & PINARD STETHOSCOPES



SI-900-07
Berliner Hammer
20 cm



SI-900-08
Dejerine Hammer
With Needle
21 cm



SI-900-09
Buck Hammer
With Needle & Brush
18 cm



SI-900-10
Troemner Hammer S.S.
25 cm
180 gms & 230 gms



SI-900-11
Taylor Hammer
20 cm



SI-900-12
Babinsky Hammer
24 cm



SI-900-13
Babinsky Hammer, with Plastic Handle
35 cm



SI-900-14
Pinard Stethoscope
Aluminium
15 cm



SI-900-15
Pinard Stethoscope
Aluminium
14 cm



SI-900-16
Pinard Stethoscope
Wooden
18 cm



SI-900-17
Pinard Stethoscope
Wooden
15 cm

TUNING FORKS



Ligamed
Corporation



SI-900-18
Alloy
256

SI-900-19
Alloy
512

SI-900-20
Alloy
1024

SI-900-21
Alloy
2048

SI-900-22
Alloy
4096

SI-900-23
Hartman
256

SI-900-24
Hartman
512

SI-900-25
Hartman
1024

SI-900-26
Hartman
2048

SI-900-27
Hartman
4096

SI-900-28
Lucae
256

SI-900-29
Lucae
512

SI-900-30
Alloy with
Weights
128

SI-900-31
Alloy with
Weights
256

SI-900-32
Taylor
128

SI-900-33
Konig
128

SI-900-34
Rydel Seiffert

